

1

2

3

4

5

6

A

A

B

B

C

C

D

D

1

2

3

4

5

6

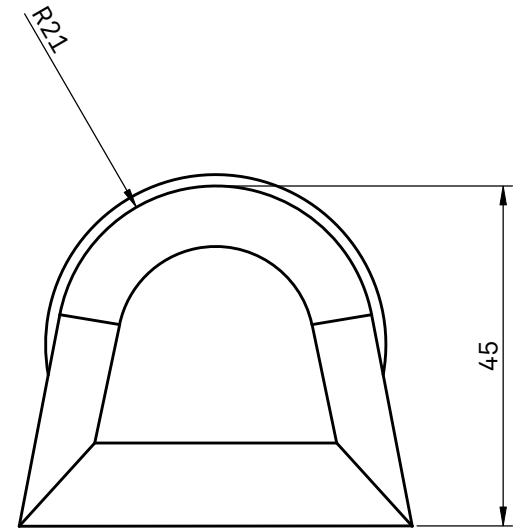
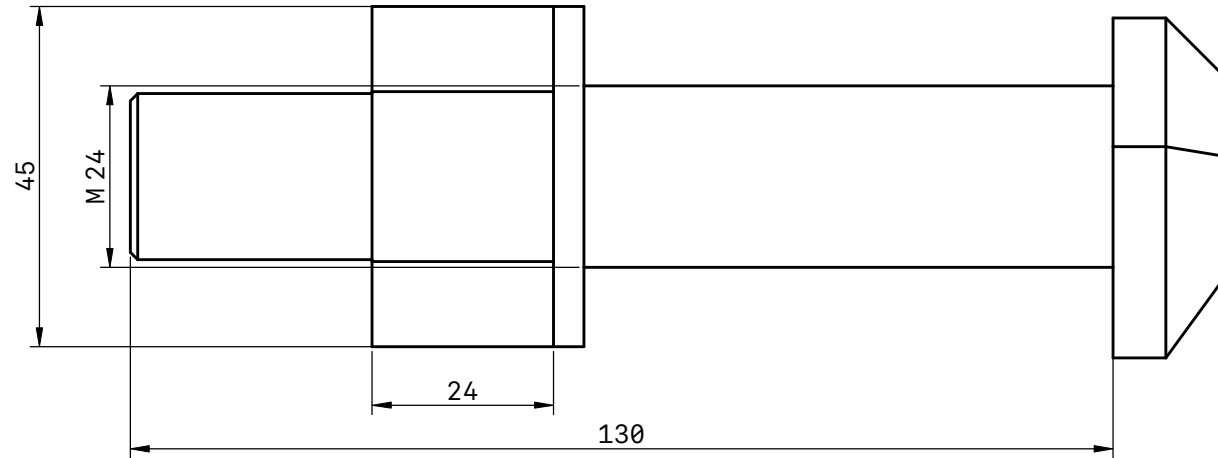

TÍTULO 1237400		
UNIDADES mm	ÁNG. PROY. 	TAMAÑO A4
ESCALA 1:1	ÚLTIMA ACTUALIZACIÓN 01/15/26	HOJA 1/1